

The mechanics of speech ontogeny

1. Syllabic cycling - derivation —The 3x3 tongue anchor matrix

- 1a. The metaperistaltic tract
- 1b. The anchor map
- 1c. The (distribution of) lingual anchors in the 3x3 matrix

2. Cycles of food processing and speech

- 2.a. The jaw rotation factor
- 2b. The jaw rotation pivot register
- 2c. Order of anchor sequence in syllable production
- 2d. The McNeilage/Davis frame-content/CV syllable mechanics interpreted as (AMS...)

3. Syllabification —the mandible-tongue unified coactivity

- 3a. The mandibular-lingual-cranial trisegment and the 3x3 temporomandibular joint register
- 3b. Jaw height relation to tongue shape is monadic unit activity.
- 3c. Five UV functions including feeding and communication are associated with specific mandibulo-lingual elevation and lingual shaping.

4. Symmetries of anchors

- 4a. And this in turn is an aspect of unified mandible-tongue behavior, so in the case of
- 4b. Jaw rotation is the essential factor (most powerful).
- 4c. Symmetries in syllable generation
 - 1. Cyclic trisegments
 - 2. Front anchor to back anchor symmetry
 - 3. Symmetry of front and back anchors centered on the central anchor
 - 4. Diagonal symmetries
 - 5. Lingual symmetries: transverse (dorso-ventral) and axial
 - 6. Spatial force symmetries between antagonists
- 4d. Shared mid-central anchoring
- 4e. Symmetry in antagonists pairs in mastication
- 4f. Symmetry in active-stable relations
- 4g. The Complexities

References

APPENDIX

- A. Demonstration of frame-content affinities
- B. Demonstration: the presence of metaperistaltic (peristalsis-based) pattern in speech[
- C. Serial-parallel functions
- D. Anatomic symmetries
- E. Mandibular pivot matrix mechanics
- F. Gesticulation
- G. The vowel quadrilateral trisector
- H. The nicto-phonetic functional symmetry
- I. Demonstration of global body frame action unity

END

The mechanics of speech ontogeny

1. The 3x3 tongue anchor matrix

This topic was covered in the introduction.

1a. The metaperistaltic tract

1. **Simple** peristaltic action is a linear sequence. **Metaperistalsis*** built into mastication and speech action is more complex; it can act across and interconnect several layers of linear sequences. The oral region of the UV tract consists of two concentric structures, the oral tract, or chamber, and the tongue. These two parts constitute a unified composite tract. Both structures can independently expand and constrict particular segments along their longitudinal axes. The unit coactivity of these two generate a variety of patterns in constriction and expansion in the composite tract. figs. 1.1 and 1.2 (Also see section *Appendix—Serial-parallel*).

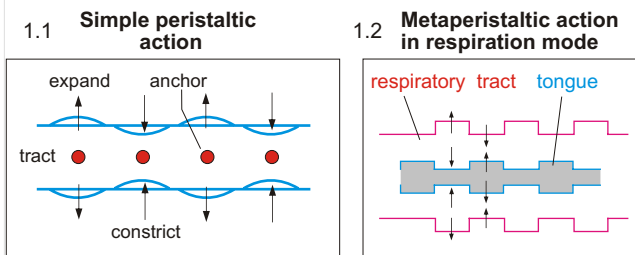

1a1. Demo: Such unified action of the tongue and the tract can be observed in a demonstration: If with a relaxed, neutral UV system, during normal oral respiration, with mouth slightly open, and with the jaw in neutral state, one medially (from all directions) constricts or expands a segment of the tongue, this action also **constricts** the tract around that segment. But it can be observed that in response to this action a axially adjacent segment of the tract spontaneously executes a compensatory **expansion** of the tract to normalize respiration. This is clearly a peristaltic pattern where a constriction of the first segment is followed by an expansion of the next segment.

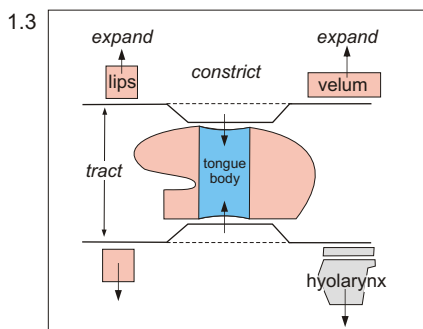

Thus, if the tongue body (middle region) constricts, then the segments of both the tongue and the tract, lying before and after the tongue body expand. That is, tongue blade and the lips open and the velum and hyolarynx act to enlarge the tract. fig. 1.3

Such UV tract behavior is organized through the anchor frame mechanism of the tract. The most important anchors of the UV tract control the diameter of the tract. The anchors are aligned on the longitudinal axis and constrict or expand the cross section. At the lowest level of framework energy these anchors function as the respiratory germinal anchors.

1.b The anchor map

Traditionally the tongue is divided into three parts: 1) the blade and 2) the body (which two constitute the oral 2/3 tongue part, and 3) the base (or posterior 1/3 tongue). The 2/3 and 1/3 tongue dichotomy derives from embryonic development and enervation of the tongue. In the AMS these two regions behave as functionally distinct regions. Suckling pump, mastication process and phoneme production are functions of the anterior 2/3. The posterior 1/3 plays a role in at least four functions: in the **stability** anchoring of the a) upper respiratory movements, of the masticatory process, of phonation in voice production, and b) **active** anchoring of the deglutition phase. fig. 1.b

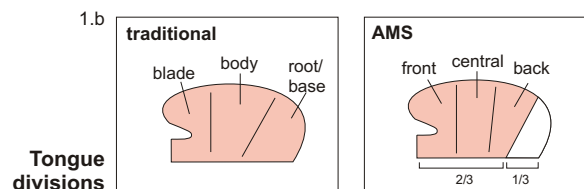

In the AMS the **three-part** division of the tongue into front, central and back regions reflects such behavior, as in **1a1**. Conversely, constriction of the F and B segments constrict and the C segment expands the tract. fig. 1.b.1

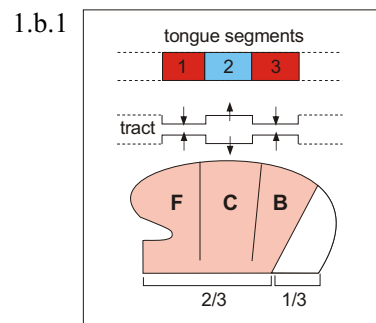

*See *The essentials of speech mechanism/Metaperistalsis*

1c. The lingual anchors of the 3x3 matrix

However, it has been recognized that in addition to horizontally triplicity, the tongue is a three-layered structure in the vertical dimension as well. This is called a "lamination" of the lingual intrinsic vertical, transverse and longitudinal muscles fibers. See Hiimae-Palmer (2003) citation on p. 14. Such a mapping is represented by a lingual anchor frame ordered as a 3x3 matrix depicted in fig. 1.c.

Both the cardinal vowel tongue height distribution, depicted in the vowel quadrilateral and its related counterpart, the vowel formant frequency chart, stand in agreement with such 3x3 matrix. fig. 1.c.1.

1. c

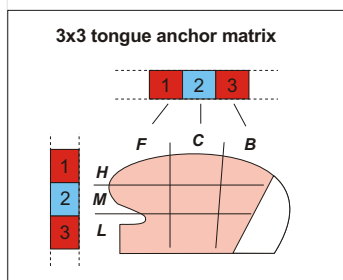

1.c.1

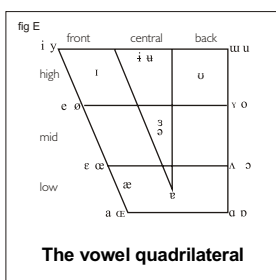

The matrix structure is functionally a combination of two trisegments, composed of the lingual anchors t-n-k and a-ə-i. More on this later. fig.1.c.2

1.c.2

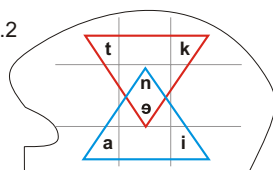

Note 1: The use of voiceless versions of phonemes in this connection is to an extent arbitrary, but since voicing is a secondary behavior, the voiceless version is a more basic representation of a particular phoneme articulation.

Note 2: The central position in diagrams 1.c.2. and 1.c.3. is shared by two anchors. Although only one is the primary agent at one time, their presence in one location signifies that they are merged and are closely coactive antagonist anchors, mutually regulating, or compensating the tract distortion generated by either one. (See **4d.** for more). Both n and ə are the pivot stabilizer anchors of their particular trisegments that constitute the combined twin trisegment framework. Fig. 1.c.3. The **blank** positions contain anchors that are products of mergers of the primary germinal anchors t-n-k and a-ə-i and are active as the fluid interconnections between the primary germinal anchors, and appear in food processing, but have no phonemic value in speech.

The germinal phonemes in the 3x3 matrix

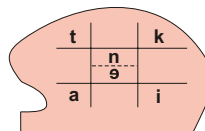

Note: in the diagram the entire tongue stands for the anterior 2/3 part.

1.c.3

2. Cycles in food processing and speech

By serially traveling through several anchor nodes of the 3x3 matrix, anchoring action can travel in an approximate circular path. All or part of the cyclicity, which in **mastication** generates a cyclic processing behavior (cf. Hiimae-Palmer 2003), is also present in **speech**, where it produces syllabic structures.

The sequential order of the anchor transformations are determined by metaperistaltic mechanics including unified jaw-tongue coactivity. fig. 2.1.

Cycling in the dual trisegment

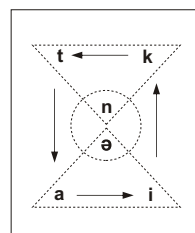

2.1

The possible paths of anchor exchanges appear in fig. A. However, each UV function employs a specific map of routes and directions. fig. 2.2

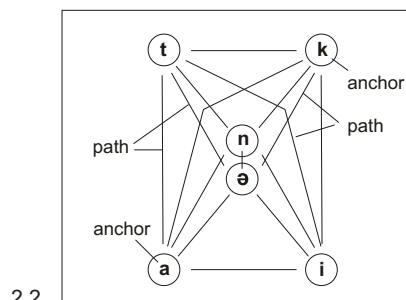

2.2

The paths and directions of the **masticatory** process and of the **suckling** pump action are shown in fig. 2.3. The former moves food that is being chewed posterior-to-anterior and then back, while the latter does so posteriorly. The difference between the two functions lies in tongue positioning in the oral space and to different pivot point of the jaw in the 3x3 matrix of the temporomandibular joint. (Cf. section **2a**). The masticatory transport phase leading to deglutition is the same as that in suckling.

Note: Both suckling and mastication may be minimally energized where mainly repetitive compressions but no transport take place. This happens in suckling when for a short period of time milk is pumped, filling the oral cavity but not swallowed, (Citation!) or in mastication when bolus is chewed without appreciable movement. In such static pumping the dorsal compressive trisegment is stabilized by the entire lower expansive trisegment as a whole.

In **speech** the continuous cyclicality is **broken** and the pieces can be rearranged in various patterns. Thus, in speech all anchor transformation routes are potentially possible, and are variously employed in different languages, but in the infant's phoneme production, where minimal energy and minimal frame shaping is available, the most likely possible routes and directions are limited, see fig. 2.4.

For the reason why an n and a-a-i appear combined in this graphic representation, see **4d**. Essentially, this group of anchors is combined or merged in a single envelope as it opens a channel for the passage of the bolus lateral to and under the tongue.

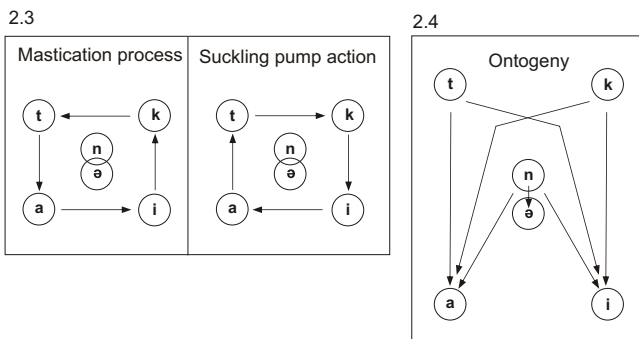

2a. The mandible rotation factor

As emphasized by MacNeilage and Davis, mandibular rotation and tongue behavior form a single inseparable monadic function acting as one. Since jaw movement is a

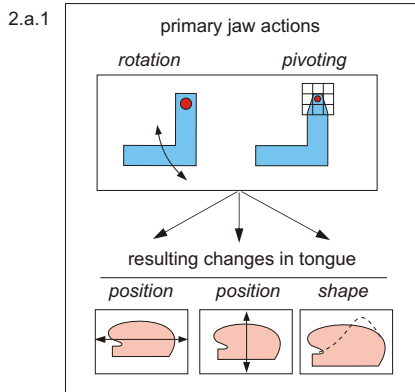

more basic, evolutionarily earlier function, and is also more powerful than that the tongue, mandibular rotation acting as the primary agent in the combined coaction always implies both an axial and vertical displacement of the tongue and simultaneous changes in tongue shape. figs . 2.a.1 and 2.a.2.

2b. The jaw rotation pivot register

The jaw pivot in the temporomandibular joint can be placed and locked according to a 3x3 matrix, in positions varying with the particular UV function, whether suckling, mastication, drinking or sound production. A particular functional **presetting** (or initialization) of the jaw pivot generates a corresponding **presetting** of tongue position and shape. fig. 2.b.1 (See *The essentials of speech mechanism* for details.)

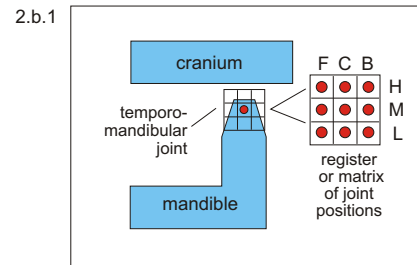
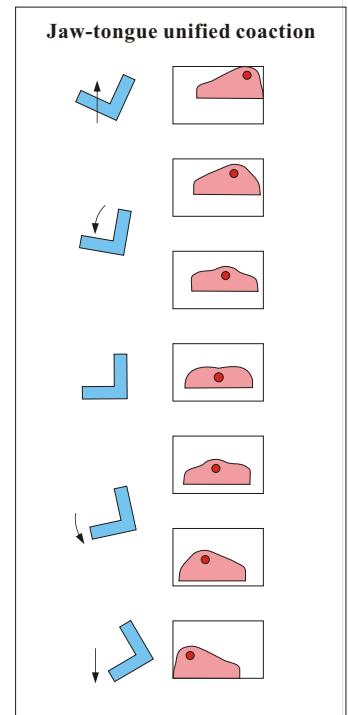

fig. 2.a.2. The monadic full or partial cyclic movements of the jaw-tongue complex are generated by the up-down rotations of the jaw. These in turn continuously generate continuously changing position and shape action by the tongue.



2c. Order of anchor sequence in syllable production

a. The **cyclic** path of tongue-jaw rotation in mastication reported by Hiiemae and Palmer (cit.!) can be defined in the AMS as a particular sequence of anchor transformations. When arising in the speech mode the lingual anchors of the mastication manifest as phoneme articulation anchors, which can interact through many different paths. Such free choice of paths is present in the mastication frame, as well, whenever non-cyclic movements are taking place. fig. 2.c.1.

We can describe the cyclic movement of mastication as transfer of action between anchors in a quasi-circular path, and in terms of trisegment cyclicality as an alternating phase exchange between two associated trisegments. fig. 2.c.2

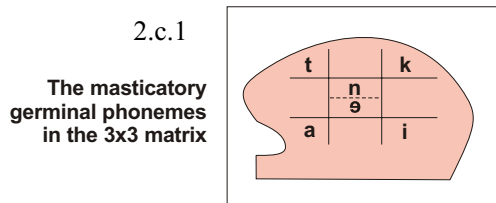
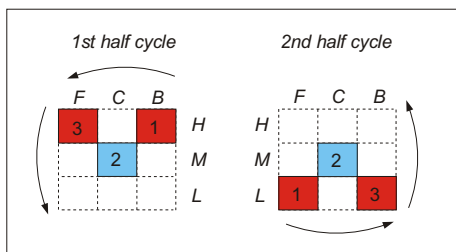
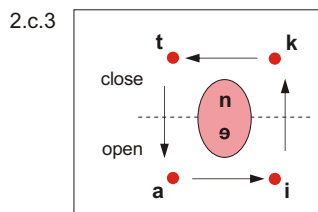

fig. 2.c.2



The sequential order of steps in the masticatory cycle is metaperistaltic, consisting of close/open/close... series represented in fig.2.c.3. The close phase serves in dorsal food compression, while the open phase opens channels under and lateral to the tongue to transport the bolus.

These same sequences are the paths of least energy in the infant's phoneme production and are primarily initiated by the jaw and follow patterns of the various symmetries discussed in 4c. In early speech, where the simplest anchor transformations are produced include /da/, /di/, /nə/, /ga/, etc., as documented by McNeilage and Davis. The syllables /ma/ and /ba/ are not derived from the processing cycle, but from the subframes of ingestion and deglutition, see 4f.



In mature speech cyclic ordering is no longer functionally significant and is not necessarily followed. Rather, the tongue and jaw anchoring moves **freely** through all possible available paths of anchor movement. Most importantly, unlike in food processing, in speech the **tongue**, and not the jaw is the **primary** agent. Mandibular input is certainly present but it plays a secondary role in aiding the action of the tongue. Jaw movement *per se* produces only masticatory and other primitive tongue shaping.

2d. The McNeilage/Davis frame-content structure

The CV syllable mechanics of early speech can be interpreted as cyclic succession of cyclic phases. The main agents of frame-content structuring are cycling and anchoral symmetries, both generated by the unified coactivity of the jaw and tongue.

The **McNeilage/Davis frame** is a sequence derivable from an event of initial tract distortion followed by a corrective tract compensation, a behavior developed from peristaltic mechanics. The production of a syllable, that is, the arising of the speech framework emerges from the respiratory mode. the tract, as it changes from its respiratory configuration, undergoes distortion and simultaneous constriction. This constriction includes heaping by the tongue, which generates the **C** articulation component (i.e., /d/ or /g/). But to correct the distorting constriction the tract expands, creating the **V** component (i.e., /a/ or /i/). Fig. 2.d. illustrates the occurrence of a CV frame within the sequence of respiratory behavior events of the tract.

Respiration itself follows an open-close sequence, as evident in alternating the active-passive states of the diaphragm and other respiratory muscles, the alternation in glottal size, the alternating protraction-retraction bias of the tongue, the alternating movements of the velum, etc.

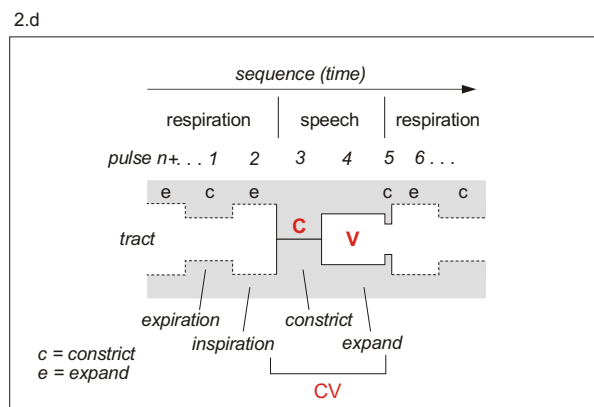

The **content of the frame** is a matter trisegmental anchor behavior, q.v., where the sequence of phonemes is determined by several interactive forces within the global framework. The factors in generation of content are examined in the following.

3. Syllabification —the mandible-tongue unified coactivity

The following is a description of the process whereby entire syllables are automatically produced in early speech. Syllable structures are systematically associated with C-V combinations that are **specific** to given monadic interactions of jaw rotations and positioning and shaping of the tongue. Such automatic processes are built into the minimally energized framework which are present during dynamically balanced resting mental or action states, as well as into more energized states.

3a. The unified coactivity between the mandibulo-lingual-cranial trisegment and the 3x3 temporomandibular joint register

The jaw, tongue and cranium are mechanically interrelated by a lines of force. (See *Structure Appendix*). This pattern can also be seen as a dual trisegmental structure through which the three regions interact. fig. 3.a

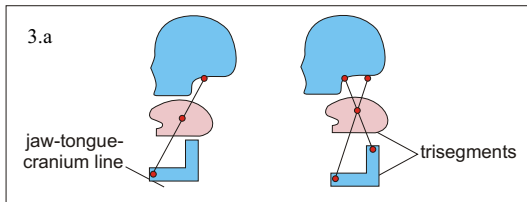

That is, apart from its rotations, the jaw **pivot** can be set or temporarily stabilized in a central, elevated, fronted, depressed, or backed position in three vertical and three horizontal lines within the joint structure, or a **3x3 temporomandibular matrix** which parallels the 3x3 matrix of the tongue. fig. 3.a.1.

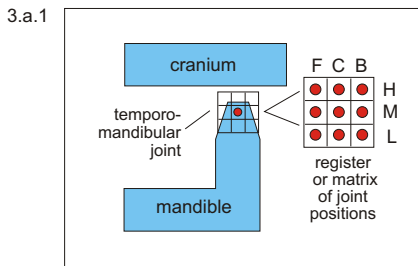

The mandible pivot matrix

This mechanism is proprioceptively verifiable and is recognizable in the distinct mandibular settings of suckling, mastication and speech. The mandibular musculature integrated with jaw ligaments, as well as lingual, hyoidal and facial coaction enable such variety of settings.

3ab. Demonstration: The movements within the 3x3 register in the sagittal plane by the temporomandibular joint are proprioceptively observable. If we rotate the jaw at various angles, **letting** it spontaneously **settle** in each location, the pivot will fit into a **specific stable** positions fall as indicated in fig. 3.ab. The matrix is observable by carefully exploring to what positions the pivot can be set to where it remains stabilized.

3.ab Jaw rotation in relation to pivot setting

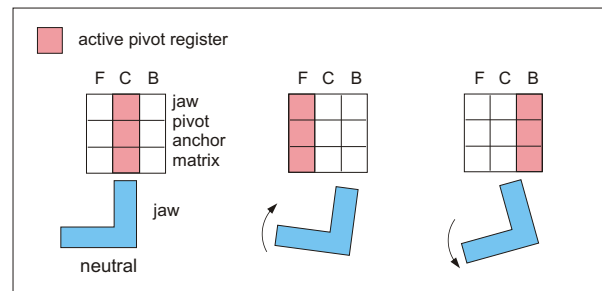

The middle column of the matrix is the normal stable position in an erect and balanced stance, but the fronted or backed columns are employed when head and body tilts occur. fig. 3.b.1

3b. Jaw height and rotation in relation to tongue position, shaping and curvature

The mandible is an important **primary** coactor both in **mastication** and **suckling**, and it is the most powerful agent of tract diameter changes and cyclic movement in the feeding processes.

Mandible **height** determines the presetting of **tongue height** and **curvature**. A **high** jaw elevation occurs with dorsally convex and elevated tongue, **medial** jaw elevation with medial tongue shape and elevation, and **low** jaw elevation with ventrally convex and depressed tongue. Either of the two mutually antagonistic organs can initiate the action of their united framework. This relationship differs with UV function. Fig. 3.b.2

Mandible height in relation to tongue shaping

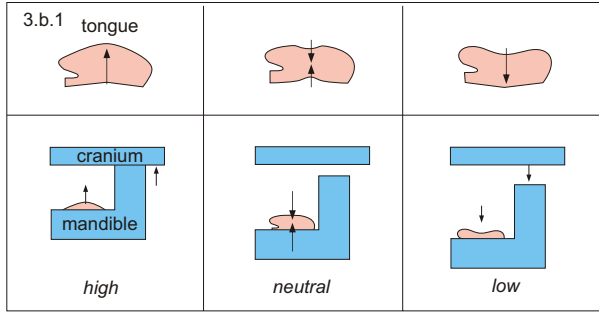

Mandible height in relation to tongue elevation and curvature

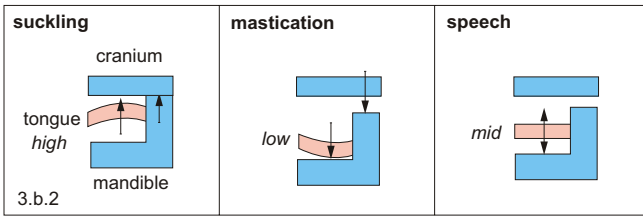

Mandibular movement in speech is more limited while the range of tongue behavior is increased and is more complex. Here consonants and vowels are associated, respectively, with dorsal and ventral tongue arching, or targeting. The germinal stop consonants are dorsal tongue constrictions, whereas germinal vowels target the tongue toward the oral floor.

Jaw **rotation** and tongue **curvature** also behave as an integrated unit action:

Upward jaw rotation associates with dorsal tongue convexity. Neutral jaw associates with level tongue and downward jaw rotation associates with ventral tongue convexity. fig.3.b.3.

The mandible rotation in relation to tongue shaping

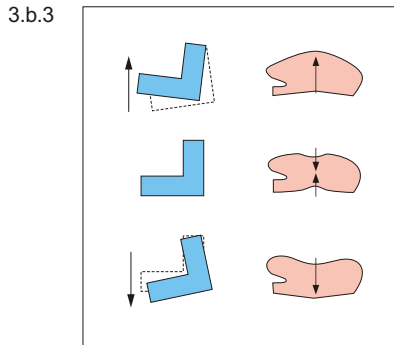

Completely articulated phonemes also contain antagonistic **compensatory** tract shaping, which opposes and thus **masks** the built-in tongue convexity.

3c. Upper visceral tract functions associated with mandibulo-lingual elevation and lingual shaping

The various UV functions including feeding and communication are associated with specific mandibulo-lingual elevation and lingual shaping. Each is associated with a particular jaw pivot position in the temporomandibular joint matrix. Fig. 3.c.

1. Respiration: medial tongue and jaw position, a balanced setting which can be maintained without effort.

2. Suckling: high jaw and high dorsal tongue—providing compression of nipple between tongue and palate. Suckling, a dorsally constricting framework, is primarily consonantal, generating the CV frames of early speech.. We can experimentally observe that an ongoing dorsal contact in simulated suckling allows approximate articulations of t/d/, /n/ and k/g.

3. Crying (by infant): high and backed tongue with expanded, ventral vocalic tract cross section, where the relatively constant open jaw prevents tongue movement. The tone is vocalic, and includes a, e, u, and i germinals.

4. Mastication: low jaw and low ventral tongue—supplying mastication space and ample jaw rotation range to allow tongue heap to contact the palate in spite of the low jaw position. At the appropriate primary dorsal or ventral phase of the mastication cycle consonants or vowels can be approximately produced.

5. Speech: medial position of both jaw and tongue—allowing space for equal tongue mobility in either consonantal-dorsal and vocalic-ventral space.

6. Drinking: ventral tongue primacy and low retracted tongue with posteriorly locked mandible and tract cross section expansion, that transports liquid through a broad channel. The germinal u replaces the i anchor in the back matrix position. We cannot actually produce vowels in the drinking framework, as that would open the airway, but we can easily produce the presetting of the articulations of /a/, /æ/ and /u/, but not /i/.

Jaw pivot positions in temporo-mandibular matrix according to UV behavior

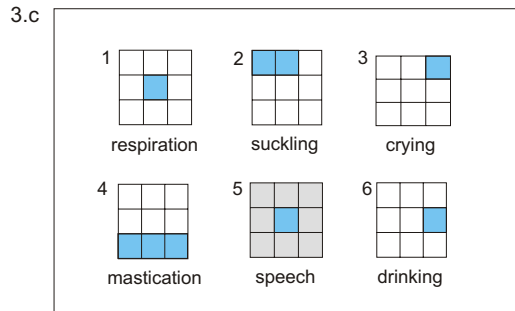

4. Symmetries of anchors

Various symmetries are built into to lingual matrix and these fundamentally determine its mechanical behavior. The symmetry appears to derive from a peristaltic pattern where expansion and contraction are symmetrical.

4a. Mandibulo-lingual coaction and germinal phonemic anchors

The mechanically interconnected consonantal t, n, k and vocalic a, e, i trisegments each form a 3x3 matrix in which each germinal anchor occupies a given matricial slot. The t and a thus fall, respectively, into the front high and the front low places, etc. fig. 4a.

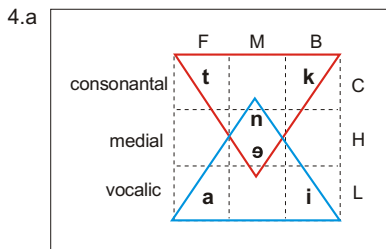

The biasing or presetting of the matrix to any of these germinal phonemes is determined by the configuration of the **unified** mandible-tongue coactivity:

- a. **High** jaw setting generates high, **dorsal** tongue that engages palatally constrictive **consonantal** anchors, t or k.
- b. **Medial** jaw and consequent **medial** tongue engage the neutral phonemes anchors n or e, i.e., **intermediate** constrictions and reduced vocalic expansions.
- c. **Low** jaw and its **low** ventral tongue engages **vocalic** anchors that are the tract expanders.
- d. In **speech** the jaw-tongue setting varies as consonantal or vocalic anchors interchange syllabically. fig. 4a.1

The anterior-posterior placement of the jaw is coactive

Mandible-tongue settings in the speech mode

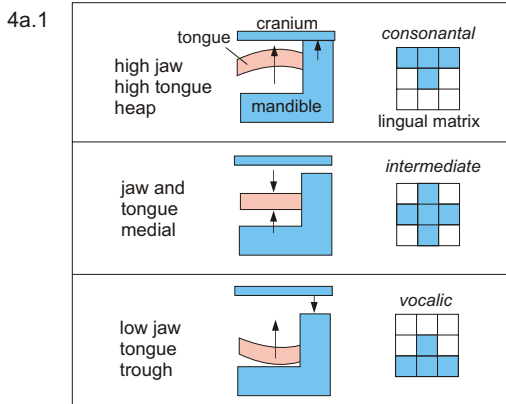

with **tongue** behavior, conversely. The settings of horizontal and vertical positioning, such as with a high-back phoneme create **mixed** tongue settings.

4b. Jaw rotation is the essential and most powerful factor

Jaw **rotation** is associated with variation in jaw **pivot height** in the temporomandibular 3x3 register. When the mandible rotates downward it also moves to a low register anchoring, and rotating up it returns to a high one.

Another relation, that of **jaw rotation** and **tongue behavior** is shown in fig. 4b.

The equivalence of mandibular rotation and tongue placement

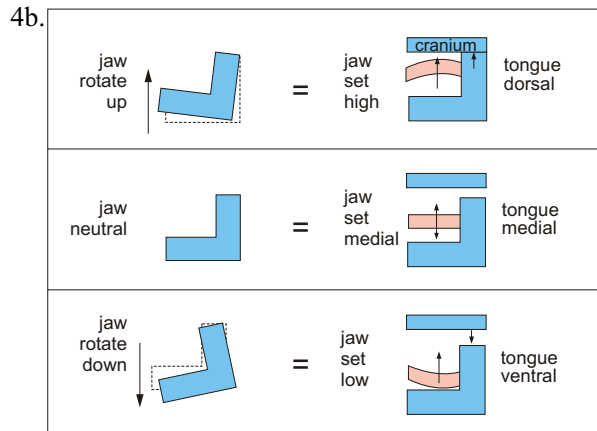

4c. Symmetries in syllable generation

Symmetry is essential in determining the various associations C and V phonemes in syllabification. The significance of symmetry is that it is across lines of symmetry that the mandibular and lingual behaviors generate anchor interchanges. Due to specific settings of mandibular and tongue positions or shape, anchor transformations will take place across specific lines of symmetry. For instance, whether the content of a CV frame is /d/-/a/ or /d/-/i/ depends the configuration of the presetting and action of the jaw and tongue. More on this **at 000**.

The **symmetries** include: See fig. 4c.

- 1. **Cyclic trisegments:** upper (constrictive/ consonantal) vs. lower (expansive/vocalic) symmetry.
- 2. **Front** anchor to **back** anchor positional symmetry.
- 3. Symmetry of front and back anchors **centered** on the central anchor.

4. **Diagonal** symmetries across cyclical paths which determine CV frame-content, q.v. ???

5. **Lingual** symmetries: transverse (dorso-ventral) and axial (front-back).

6. **Spherically concentric** spatial force symmetries between antagonists. E.g., $\underline{n}/\underline{ə}$ relationship, where \underline{n} associates with inward forces and $\underline{ə}$ associates with outward forces. Cf. 4.d.2.

7. **Antagonist** counterbalance in all cases of symmetry.

4d. The shared mid-central anchor

Two trisegments, the consonantal $\underline{t-n-k}$ and the vocalic $\underline{ə-i}$ are combined so that their mid central anchors \underline{n} and $\underline{ə}$ are united as **spherically concentric** antagonist pair, around which the various peripheral anchors operate. fig. 4.d.1

The UV framework and its subframeworks are all three-dimensional structures, but at this point can be analyzed in a two-dimensional form. However, the three-dimensional relationship of the \underline{n} and $\underline{ə}$ anchors is worth noting. Either anchor may at one time be the **primary** agent, while the other one then serves as tract **corrector**. The medio-lingually constrictive consonantal \underline{n} is thus compensatorily adjusted for optimal respiratory-glottal setting, by the tract expanding vocalic $\underline{ə}$, and vice versa. The \underline{n} forces are centripetal and the $\underline{ə}$ forces are centrifugal. The tension map of the combined antagonist pair $\underline{n}/\underline{ə}$ anchor structure can be represented as medial consonantal body surrounded by a vocalic shell. fig. 4.d.2.

4c. **The types of symmetries**

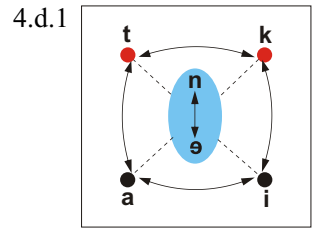
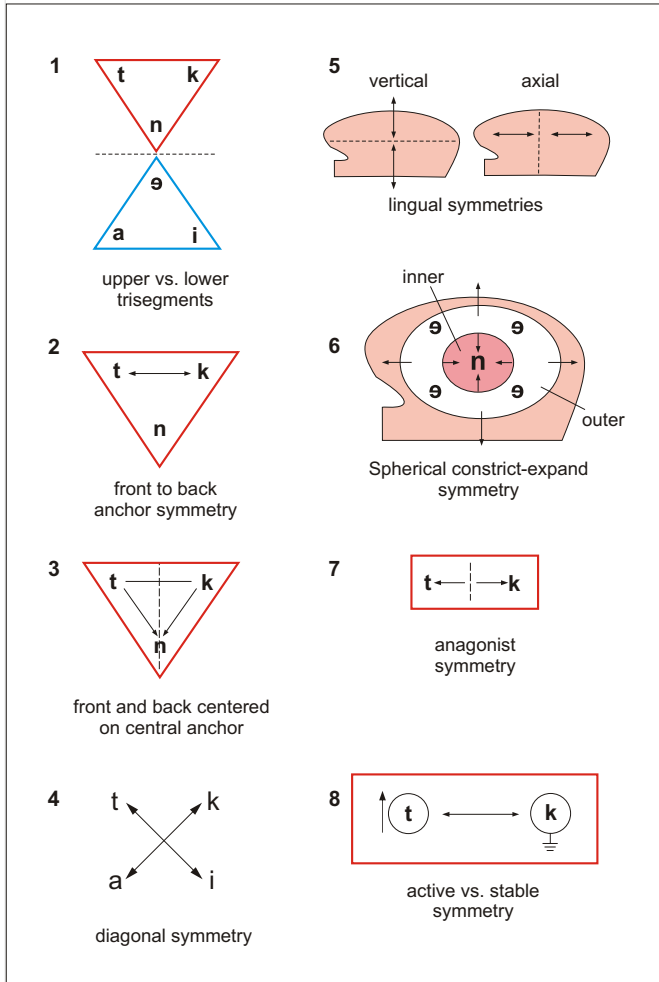

4.d.2.

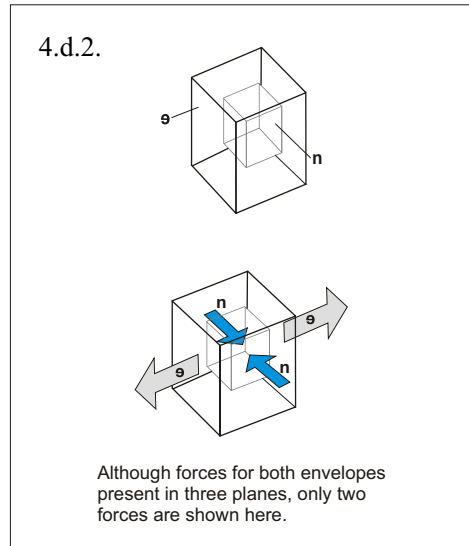

4e. Symmetry in antagonist pairs in mastication

1. t and k are antagonist pairs, respectively, in lingual dorsal heap (elevation) and trough (depression) formations, as well as in moving the bolus, in coactivity with n. fig. 4.e.

2. During their own antagonist coaction the activities t and k are stabilized by their shared primary antagonist anchor n.

3. n momentarily becomes the active agent in midpoint of the dorsal phase of the cycle, during which time t and k are the antagonist secondaries of n.

4. During k anchor action of forming the back peak, t and n momentarily combine as antagonists, and k similarly combines with n during t activity.

5. The p anchor, involved in labial closure, is the antagonist of the m anchor. This is evident is deglutition: jaw and lip closure is a requisite of deglutition, but not of mastication. This mechanical relationship between p and m underlies the emergence of /p/b/ and /m/ in early speech.

Symmetries in antagonist pairs and their envelopes

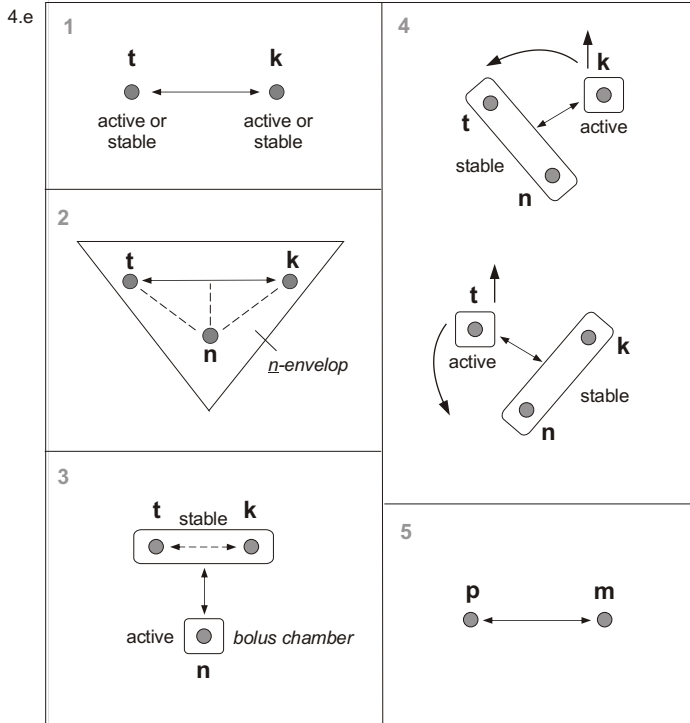

4f. Symmetry of active-stable relations in mastication

In antagonist relation between two forces the prime mover or agonist plays a **primary** role, and can be defined as **active**, while the antagonist is secondary and can be defined as **stable**, as it stabilizes the reference framework for the primary activity.

However, in terms of anchoral hierarchy, the stable anchor, part of the ground framework of action, has a higher rank. To avoid ambiguity, the term "primacy" is not used in describing the types of symmetries illustrated in fig. f.

1. Throughout the mastication process the central anchor, or n, is the high rank stable anchor against which the t and k anchors perform. In the mid dorsal cycle phase, halfway between the frontal and back hill formation n becomes momentarily active and t and k take on a secondarily superimposed stabilizing role. fig. 4.f (1).

2. and 3. However, as t and k are also mutual antagonists, and each in turn becomes active or stable, their two anchors form a superimposed secondary subframe, in which the stable k joins the stable n while t is active, and conversely. figs. f(2) and f(3).

4. **Mastication** and **deglutition** function as an antagonist pair, alternately active or stable, pivoting on the m lingual anchor. Both actions are primarily stabilized by the m fulcrum. fig. f(4).

This is evident in that during food processing (chewing), the sound spontaneously producible is /n/, while deglutition, and the aroma-sensing post-deglutition phase similarly produce a spontaneous /m/. Pleasure taste is expressed during mastication or after deglutition as /m/, as well.

Although the **mastication** framework is the one automatically and continuously present in feeding, while the deglutition framework operates only momentarily, this is only true in normal head positioning. If the head is gradually tilted backward, keeping a neutral tongue and jaw, the **framework** of mastication transforms first to the **drinking**, and then to the **deglutition** framework.

Symmetries in active/stable pairs

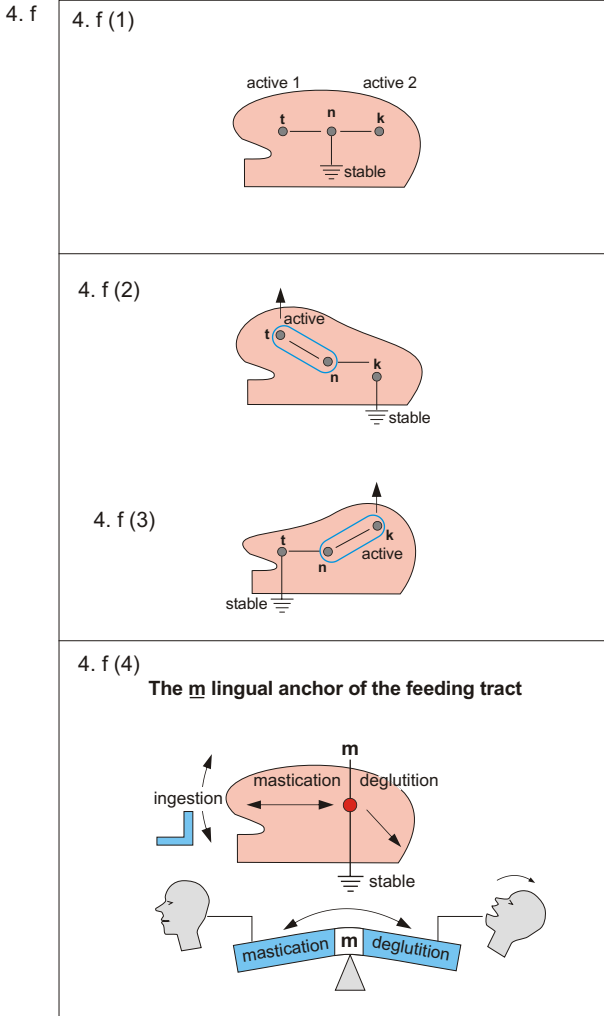

Head tilt generated presetting

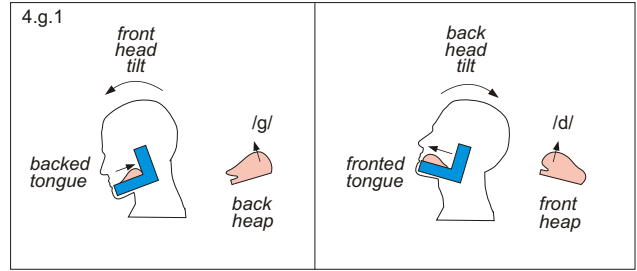

2. Initial presettings of tongue-plus-jaw configurations.

E.g., if the **tongue is neutral** and the jaw is initially set **forwarded** in the temporomandibular joint, the tongue is preset for /g/, but for a **retracted** jaw it is preset for /d/. If the **jaw is neutral** and the tongue is initially **forwarded** the presetting is /g/, and the jaw retracts, but with tongue **retracted** it is /d/, and the jaw protracts. fig. 4.g.2.

4.g.2 Initial tongue or jaw presettings

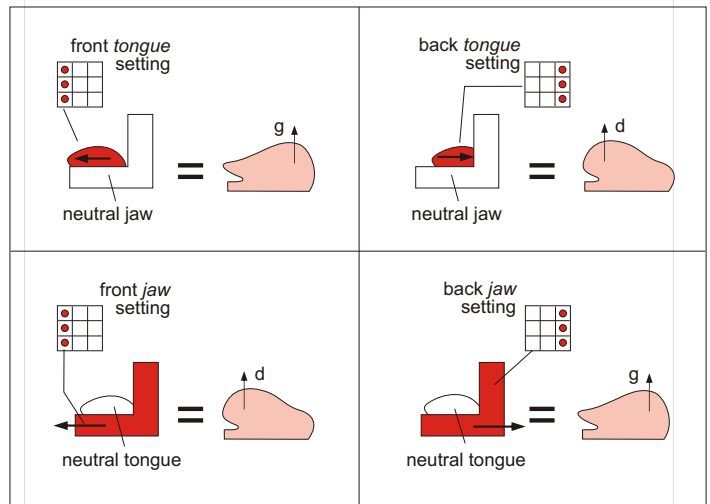

4g. Complexities in determining CV frame content

The speech framework of the UV contains a significant number of parts and, due to their monadic unified interaction, action by any part initiates and influences the action of the others. For this reason we cannot predict framework behavior except in states of minimally energy and mechanical equipoise.

The **variable** factors that determine CV frame content in the UV include the following:

1. **Head tilt** (sagittal rotation). E.g., with backward head tilt and with jaw closed, the neutral tongue is **backed** and produces an **anterior** heap, or /d/. With forward head tilt the tongue is **fronted** and produces a **posterior** heap, or /g/. fig. 4.g.1

3. Initial degree of jaw rotation angle. E.g., with neutral tongue, forceful upward rotation of the jaw produces a /d/; a neutral jaw produces /n/; an opened jaw produces /g/. fig. 4.g.3.

4.g.3. Initial jaw angle generated presetting

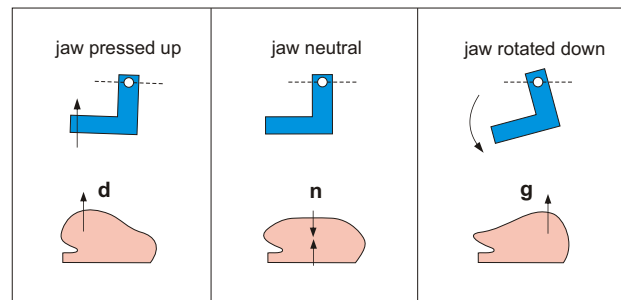

4. **Abdominal vs. thoracic respiration.** The relative proportions of **abdominal** and **thoracic** respiratory forces occurring with a neutral tongue and jaw unit generates spontaneous tongue shaping. If the body and head are together tilted **backward**, **abdominal** respiration dominates and the tongue presets for the /g/ heap. With body **forward** tilt, **thoracic** respiration dominates and the tongue presets for the /d/ heap. Fig. 4.g.4.

4.g.4 **Abdominal vs. thoracic respiration**

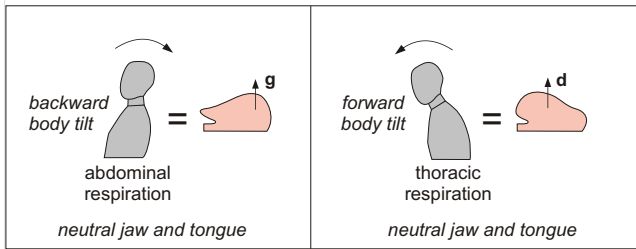

5. **Forces applied to the jaw.** The amount and direction of forces applied to the mandible directly affects presetting of the tongue shape. Fig. 4.g.5 illustrates how these factors determine the **vowel** setting of the tongue. To demonstrate these behaviors it is necessary to maintain an erect, balanced body and head stance and to apply uniform, balanced force to a neutral tongue and speech tract.

4.g.5 **Vocalic frame content presetting by force applied to jaw (in erect stance)**

articulatory presetting	jaw action	phonemic presetting
t +	no force kept closed	= /ti/
t +	downward force kept closed	= /ta/
k +	upward force kept closed	= /kə/
k +	no force hanging open	= /ki/
k +	kept open against upward force	= /ka/

6. The **pressure sensitivity** of the tongue surface. If a small object (e.g., a small grape seed) is applied to the any axial segment of the tongue, the lingual response will be curvature (heap) formation at that particular segment: bolus in the front: /k/ heap; bolus in center: /n/ trough; bolus in back: /d/ heap. This behavior pertains to food processing, but in speech, at least during its ontogeny, may play a role because the pressure *per se* of the tongue on the palate stimulates tongue shaping response. Thus, a lingual anchor presetting for /k/ in the respiratory (pre-speech) mode would generate a /d/ heap once the speech mode is entered and forces are applied. This alternation of front-to-back positions is due to alternation in the mode change. fig. 4.g.6.

As solid food is liquified during processing, the dorsally active d-n-g half cycle transforms to the ventrally active a-ə-i half cycle. Here food contacting the tongue blade ventrally and laterally a generates a ventral and lateral heap and trough, through which the bolus is propelled backward, returning to its dorsal position.

This suggests that, whatever non-balanced shaping it executes, the presence of local pressures on the tongue itself

4.g.6. **Lingual sensitivity to input location**

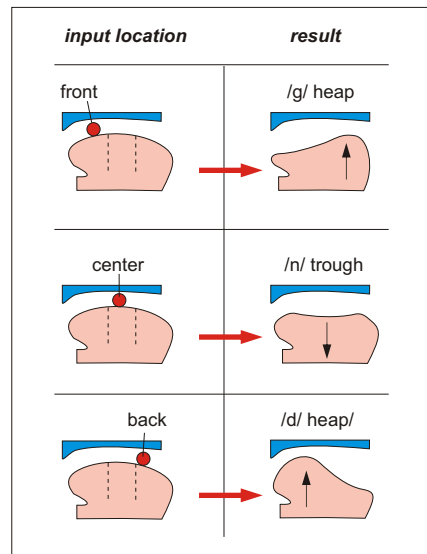

7. **Facial behavior: smiling.** The tongue spreads and protracts in the subframe of smiling, placing the tongue against the coronal palate, forming a /d/ heap which if employed in speech would generate a /d/. In the smile or laughter a /d/ is not produced because their subframes have a nasal respiratory component which keeps open the air tract, precluding the labio-palatal plosion of /t/d/. However alternate plosive oscillation occurs at the glottis and/or diaphragmatic and velo-nasal valves.

A type of dentalized version of /t/d/ does manifest in certain forms of smiling and laughter, especially in young children. Cf. "tee-hee" and /ts/ sounds.

On termination of the smile, the tongue retracts and the frontal d-n-g subframe anchoring transforms and becomes configured to the more posterior m anchor. Smiling is important infant behavior, and its phonemic presettings can explain why /d/ and /m/ are prominent in early speech. fig.7.g.

4.g.7 Facial muscle (mouth) factor in tongue shaping

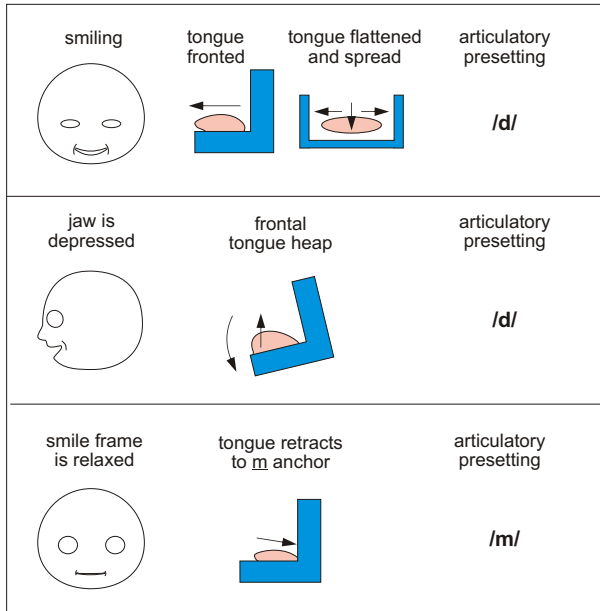

8. The configuration of the infant's oral framework.

In the infant's oral map the tongue is naturally preset for suckling, aiding labial, mandibular and lingual dorsal pressure in pumping. Such dorsally convex presetting may be demonstrated by the fact that, as commonly known, if while speaking, one palatally presses the tongue, one's pronunciation simulates that of a child. fig. g.8.

4.g.8 Infant tongue suckling oriented framework

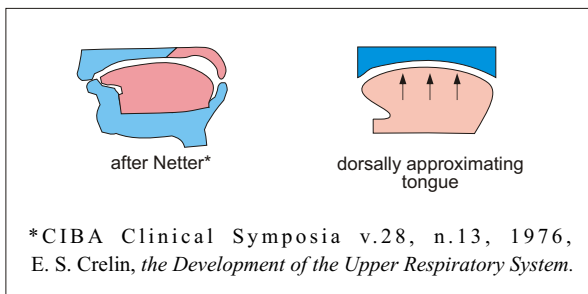

References

Bosma J.F., et. al., *Ultrasound demonstration of tongue motions during suckle feeding*, Dev Med Child Neurol. 1990 Mar;32(3):223-9.

Voloschin L.M., et al., *A new tool for measuring the suckling stimulus during breastfeeding in humans: the orokinogram and the Fourier series*, Journal of reproduction and fertility 1998, vol. 114, no2, pp. 219-224.

Zoppou C., Barry S.I., Mercer G.N., *Dynamics of human milk extraction: a comparative study of breast feeding and breast pumping*, Bull Math Biol. 1997 Sep;59(5):953-73.

Kathleen M. Buckley and Gloria E. Charles, *Benefits and challenges of transitioning preterm infants to at-breast feedings*. International Breastfeeding Journal 2006, 1:13.

Michael W. Woolridge, *The anatomy of infant suckling*, Midwifery, 1986 Dec; 2(4): 164-171.

Karen M. Hiimae and Jeffrey B. Palmer, *Tongue movements in feeding and speech*, Crit Rev Oral Biol Med, 14(6):413-429 (2003).

Karen M. Hiimae, et. al., *Hyoid and tongue surface movements in speaking and eating*, Archives of Oral Biology 47 (2002) 1127.

Peter F. MacNeilage, *The Frame/Content theory of evolution of speech production*, Behavioral and Brain Sciences, 1998, 21, 499-546.

Citation, re: paragraph 1.c., page 3:

Hiimae-Palmer (2003) refer to the **laminated** tongue: "Recent anatomical research in non-human mammals has shown that the intrinsic muscles can best be regarded as a 'laminated segmental system' with tightly packed layers of the 'transverse', 'longitudinal', and 'vertical' muscle fibers. Each segment receives separate innervation from branches of the hypoglossal nerve. These new anatomical findings are contributing to the development of functional models of the tongue, many based on increasingly refined finite element modeling techniques."